

OPTICAL BUILDING BLOCKS CORPORATION

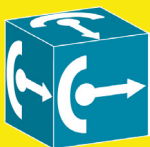

PowerArc™

Compact High Intensity Light Source

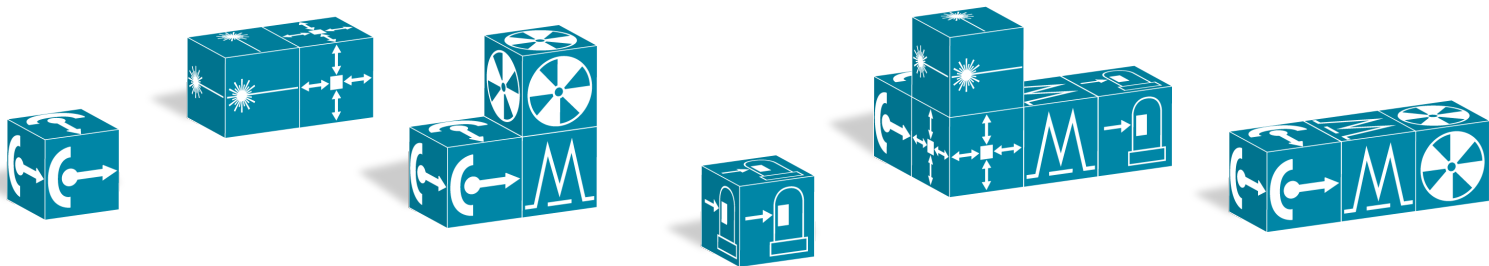

OPTICAL BUILDING BLOCKS



CORPORATION

General Information

If you need a broadband light source in the UV/Vis/NIR portion of the spectrum, an arc lamp has no peer. The intensity of an arc lamp is extremely high and, depending on the lamp, reasonably continuous throughout the region from 240 to 1200 nanometers. Usable intensities are even available in the deep UV to 180 nm and in the near infrared to 2500 nm.

While arc lamps themselves are very similar from manufacturer to manufacturer, the arc lamp housings that contain these lamps are very different. As such the arc lamp housing can have a dramatic affect on how an arc lamp illuminator performs. The arc lamp housing needs to hold the lamp, provide electrical contact, collect and deliver light emitted from the arc, and maintain a good operating temperature. We believe that our long experience in light source design is what allows us to give you a unique light source that truly is a better design

Key Benefits of the OBB PowerArc™ Lamp Housing Design

- Delivers Five to Six Times More Light
- Ozone Free Lamp Housing with No Venting Chimney
- More Compact
- Environmentally Friendly Producing no Ozone and Consuming Less Energy
- Less Expensive

Power Output

Users of old style vertical arc lamp housings are throwing away as much as 90% of the lamps output, due to poor collection efficiency. These old style vertical lamp housings have a collection lens in front of the arc lamp and sometimes, but not always, a back reflector behind them. The problem with this old design is that only the light that actually strikes these optical elements is delivered outside of the lamp housing. All other photons emitted by the lamp are wasted, simply heating the inside of the lamp housing. Conversely the unique OBB PowerArc™ lamp housing has an enveloping ellipsoidal reflector that collects virtually all of the light emitted by the lamp arc, delivering those photons to a secondary focal point outside of the lamp housing, and it does so without any lenses.

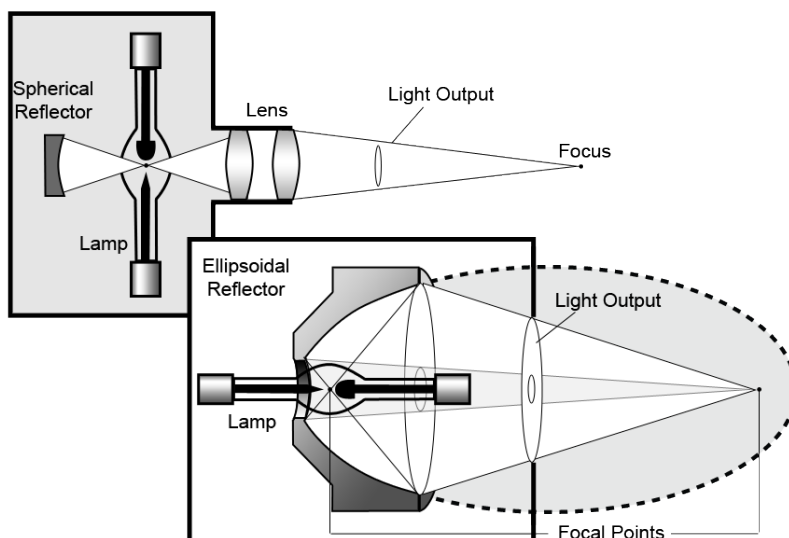

For the same bulb, the OBB PowerArc™ delivers 5 to 6 times more light, to the secondary focus! That means that an OBB PowerArc™ lamp housing with a 75 watt xenon lamp provides the equivalent optical power of a 450 watt xenon lamp in an old style vertical lamp housing. And it does so with greater power density due to a smaller focal spot, and at a small fraction of the cost of a big old 450 watt illuminator.

Lamp Housing

At the heart of the OBB PowerArc™ lamp housing is a proprietary on-axis ellipsoidal reflector. Our reflectors collect up to 70% of the radiant energy from the arc lamp, versus only 12% for typical condenser systems in vertical lamp housings. The ellipse literally wraps around the arc lamp, collecting 5 to 6 times more output power than a conventional system.

The arc source is located at one focal point of the ellipse, and the radiation is reflected by the ellipse to the secondary focus which is actually outside of the lamp housing. Since the light is brought to a focus by reflection rather than refraction (through a lens), there are less losses from absorption or lens-surface back-reflection. This design is so efficient that an OBB PowerArc™ lamp housing can deliver up to 11 times more optical power into a given smaller area than a conventional lamp housing. This is critical when illuminating light guides, monochromator slits, pinholes or other small areas.

What this means is simply that you get the same output with an OBB 75 W system as with a conventional 450 W system. You obviously will save money and space.

While conventional lamp housings resemble chimneys emitting ozone and requiring cumbersome venting, the OBB PowerArc™ has a sealed lamp housing that requires no ozone venting.

Lamp Housing Specifications

Lamp Power Capacity	75 to 150 watts
Height	100 mm (3.9 inches)
Width	100 mm (3.9 inches)
Length	210 mm (8.3 inches)
Weight	1.9 kg (4.2 lbs)
Window Diameter (D)	65 nm

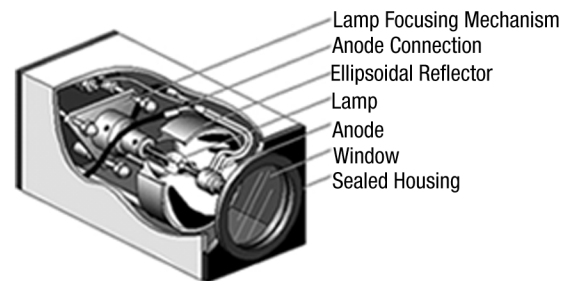

Lamp

You have a choice of lamps depending on the spectral output that you require. Of course you may order different types of lamps for the housing, they are interchangeable.

There are two types of arc lamps available—xenon and mercury. The xenon gas used in the lamp provides continuous spectra from 180 nm to 2,500 nm of course at varying intensity. The mercury provides a line spectra. The spectral curves for xenon and mercury are normalized (relative intensities) therefore it is not obvious that the mercury lamps, intensity—where it emits, exceeds that of the xenon lamp. Because of the smaller arc size, the mercury lamp can also provide greater intensity in a smaller area (greater brightness) than the xenon lamp.

We also have an optional tungsten-halogen filament lamp for NIR applications.

Arc lamps come with a quartz or suprasil envelope depending on the application. Quartz lamps do not transmit the deep UV below 240 nm. Suprasil lamps do transmit the deepest UV output from the arc down to about 180 nm. For either type of lamp envelope our unique lamp housing design does not create ozone and therefore requires no ozone venting.

Lamp Wattage	Lamp Type	Nominal Arc Gap
75 watt	Compact Arc Xenon	0.8 mm
100 watt	Tungsten Halogen Filament	4 x 2 mm
100 watt	Mercury	0.25 mm
75 watt	Suprasil Compact Arc Xenon	1.3 mm
150 watt	Compact Arc Xenon Ozone free	2.1 mm
150 watt	Compact Arc Xenon	2.1 mm

The 75 watt xenon lamp and 100 watt tungsten-halogen lamps require no cooling whatsoever. The larger wattages of lamps require water cooling.

You can either get your water directly from the cold-water tap (can be a problem if the water is hard or when water is not available) or from an inexpensive circulating water bath option that we provide.

We have selected water-cooling over air: because it allows us to make a more compact housing; seal in the ozone and eliminates the need for venting.

Reflector

Our ellipsoidal reflectors are proprietary in design and the coating used. They are NOT electro-formed reflectors, which can distort with heat, and can degrade within months. Our proprietary design ensures that distortion of the critical ellipsoid can not occur as the lamp reaches its operating temperature. This ensures thermal stability of focus. The coating ensures reasonably long operating life—typically 3-5 years.

With an OBB PowerArc™ lamp housing you have a choice of three different ellipsoidal reflectors depending on your requirements. The proprietary reflectors OBB Corp uses allows for the great 70% collection efficiency. In addition to collection of light the reflectors are used as focusing elements. Hence the selection of a reflector determines the focal length. The different focal lengths correspond to the different “focal cones” of light coming from your lamp housing. This “focal cone” is variously referred to as f/#, Numerical Aperture, and/or acceptance, convergence, or divergence angle.

The f/# is important when considering matching a light source to some other component, for example: fiber optics, liquid light guides or monochromators. However the f/# does not affect the light collection as it does in a simple lens design. The shape and size of the ellipsoidal reflector determines how much light is collected from the lamp arc, and the amount of delivered light is the same for all of OBB’s reflectors. Selection of your OBB reflector f/# is primarily based on matching the focal cone of the converging beam with any secondary optical elements you will be using. However the f/# also determines the focal distance and the focal spot size with lower f/#’s having shorter focal lengths and smaller spot sizes.

The spot size at the focus is directly related to the original arc gap size of the lamp and the focal length of the reflector. The larger the arc, or the longer the focal length, the larger the spot size at the focus. Hence if you want to have the maximum power in the smallest spot select the fastest focal length (f/1) and the smallest arc size lamp (100 W Mercury). This is another unique benefit of the OBB Corp’s system; we give you the most power in the smallest spot. No one using an arc lamp can match us in this regardless of their systems size or cost.

Reflector Selection Guide	f/4.5 reflector	f/2.5 reflector	f/1 reflector
Focal length (F)	379 mm	240.5 mm	112 mm
Focal point from housing (X)	284.35 mm	151.46 mm	22.25 mm
Beam angle (α)	14.5 degrees	28 degrees	45 degrees
Numerical Aperture N.A.	0.12	0.24	0.45

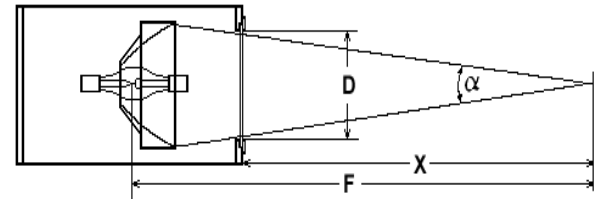

Window

The OBB PowerArc™ is a sealed arc lamp housing. You have a choice of the optical front windows, depending on the spectral output that you require. Please refer to the transmission spectra of the three types of windows available. If you plan to use different types of lamps in your lamp housing, you may want to order different windows or select Suprasil since it will transmit all spectra.

Pyrex

Above 350 nm

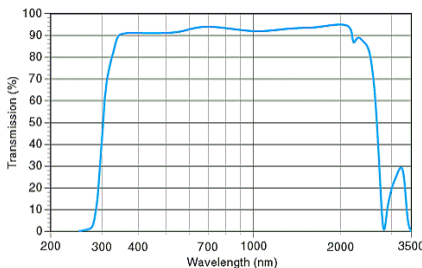

Quartz

Above 250 nm

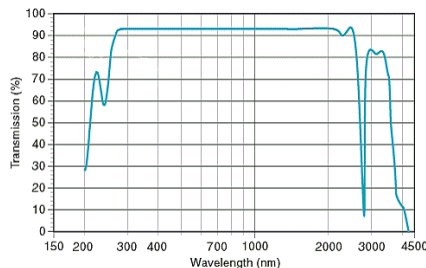

Suprasil

Above 180 nm

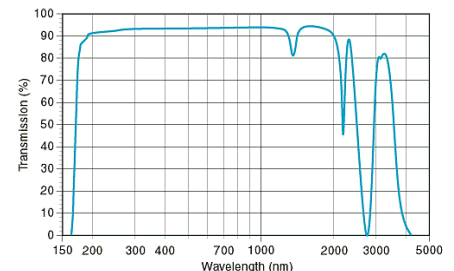

Power Supply

The PowerArc™ lamp housing comes with one of two choices for the power supply and igniter.

Dedicated 75 or 100 Watt Power Supply

If you are only ever going to use the 75 watt xenon lamp or 100 watt mercury lamp with your OBB PowerArc™ lamp housing, then we offer two dedicated compact power supplies and igniter units that are integrated onto the lamp housing. They are specially designed switch mode power supplies offering outstanding stability with a simple push button, electronically safe, ignition. In fact, although they are not DC regulated power supplies, OBB carefully designed them to offer virtually identical stability specifications to our linear power supply. When used with the PowerArc™ lamp housing this illuminator offers a very small form at a very affordable price.



Universal 75 to 150 Watt Power Supply

If you need to use a lamp other than 75 or 100 watts, then we offer a universal highly-regulated, constant current, linear, DC power supply. This universal power supply provides very stable power for arc lamps. It can also be used with a 100 watt tungsten-halogen filament lamp for enhanced IR output. Designed for use with various lamp housings, it may be used with lamp housings from other manufacturers. When used with an arc lamp in OBB's PowerArc™ lamp housing, this stand alone power supply is connected to a compact igniter that is integrated onto the lamp housing for electronically safe ignition.

The DC regulated power supply pictured below has a current adjust for different operating wattages and can display operating voltage, wattage or current.



Ignition Safe Igniter

Ignition noise can disrupt, or even destroy, sensitive equipment in the vicinity of an arc lamp during start-up. This can be quite a concern in a crowded lab environment. OBB Engineers introduced an igniter that is integrated onto the lamp housing. This design provides an effective EMI shield which contains the EMI pulse, providing a safer and more convenient environment in which to do your research.

Specifications

Optical Specifications

	75 W Xe			100 W TH Filament			100 W Hg			150 W Hg		
Reflector	f/1	f/2.5	f/4.5	f/1	f/2.5	f/4.5	f/1	f/2.5	f/4.5	f/1	f/2.5	f/4.5
Broadband Optical Power at Focal Point (W)	7.5	7.5	7.5	3	3	3	10	10	10	15	15	15
Focal Point (FWHM, mm)	1.5	3.2	5.4	7.5	18	30	0.9	1.2	3.4	2.6	5.8	10.5

75 Watt Switch Mode Power Supply Specifications

Input (user selectable)	90–274 V AC, 50–60 Hz
Power Rating	50 to 100 watts
Operating Voltage	10 to 25 volts
Operating Current	3 to 7 amps
Pre-Ignition Voltage	65–75 V DC
Ripple at Max Current	< 3% peak to peak
Stability After Warm-up	0.5%
Line Voltage Regulation	< 0.5% current variation for 5 volts line change

75 to 150 Watt Universal Power Supply Specifications

Input (user selectable)	105–120 V/60 Hz or 210–240 V/50 Hz
Power Rating	0 to 150 watts
Operating Voltage	10 to 24 volts
Operating Current	0 to 8 amps
Pre-Ignition Voltage	> 85 volts
Ripple at Max Current	< 10 millivolts
Stability After Warm-up	0.2%
Line Voltage Regulation	0.1% current variation for 5 volts line change
Load Regulation	0.1% current variation for 50% change in load impedance
Dimensions	4.5 x 10.75 x 12.5 inches, 11.5 x 27.3 x 31.8 cm
Weight	12 pounds, 5.45 kg

Compatible Optical Building Blocks

The PowerArc™ illuminator is one of many interconnectable optical components. Hence the name of our company, Optical Building Blocks Corporation. These Optical Building Blocks can be ordered together to form a complete subassembly or they can be subsequently added to an existing OBB component. In fact there are enough OBB components to choose from to build your own complete optical system for various spectroscopy requirements.



Monochromators

OBB has an excellent 200 mm focal length monochromator. If you would like to couple the PowerArc™ illuminator to our monochromator, then we have a light shield adapter tube to physically connect them and create a tunable illuminator. Refer to our Tunable PowerArc brochure for more information

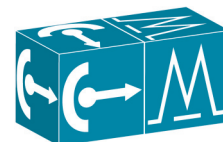

Optical Choppers

If you would like to convert the continuous illumination of the PowerArc™ into a pulsed light source then we have an optical chopper that can do the job. It can be used on a stand alone basis or it can be physically mounted into a light shield adapter tube that would become an extension of the PowerArc™ lamp housing.

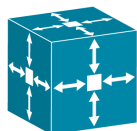
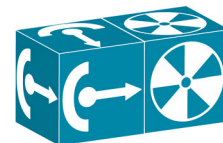

Sample Compartment

If you would like to couple your PowerArc™ lamp housing into a sample compartment, then we have an ideal solution. The OBB QuadraCentric sample compartment is an excellent unit that has various sample handling capabilities. There is also a light shield adapter tube that directly couples the PowerArc™ lamp housing to the sample compartment with matching optics to focus light into the sample. You can then have up to three other input or output optical channels to or from the central sample holder. So you could create a right angle fluorometer or scatter system or a straight through absorbance spectrometer with the appropriate detection components. For each optical channel in the sample compartment there is also a filter holder for wavelength selection.

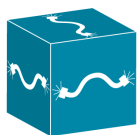
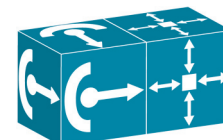

Liquid Light Guides

Liquid light guides have become the flexible light guide of choice for non laser based light handling. OBB Corporation has a selection of liquid light guides to choose from. If you would like to use a liquid light guide with your PowerArc™ lamp housing then we have an adapter tube that will connect the lamp housing to the light guide. It can even accommodate an IR filter to prevent damage to the light guide from being photodamaged.

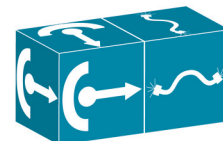

Applications

Applications for compact arc lamp housings cover a broad range of scientific, OEM and research applications. Arc lamp systems are the light sources of choice for a variety of spectroscopy systems. Such as:

- Fluorometers,
- UV /Vis Spectrometers
- CD Spectrometers
- Stopped-Flow Spectrometers
- Microscopes
- Tunable Illuminators

Arc lamp systems are also used for a broad a range of applications almost as diverse as the wavelength range across which they emit.

- Solar Simulators
- Photochemistry
- Photo-Activation
- Photobiology
- Spectroscopy
- Optical Teaching Labs
- Pump Probe
- Dermatology
- Catheter Illumination

OEM

One of Optical Building Block Corporation's major markets is for O.E.M applications. Whether its supplying standard off the shelf products, modified products or completely custom designed new products, OBB Corp. has the development team of engineers and scientists to meet your specific needs. Subsequent to the development OBB Corp has the manufacturing capability to produce the product efficiently, reliably and economically in any quantity that you may need.

Our technical expertise resides in developing:

- Specialized light sources
- Monochromators
- Spectrographs
- Microscope accessories
- Low light or fast detection from UV to NIR
- Specific luminescence, fluorescence, phosphorescence systems for use with reagents
- Polarimeters
- Software related to instrumentation control and analysis

In general we specialize in equipment related to the application and uses of light.

OBB has a policy of continuous product development and reserves the right to amend part numbers, descriptions and specifications without prior notice.

